



# DTF 35 SH

## LPG

Article code	Power	Wattage/HP
800025	LPG	26 kW / 35 HP

Key features	
Cutting width	35 cm / 14"
Distance to wall	10.7 cm / 4"
Cutting depth	Up to 25 mm / 1"
Production / h	Up to 120 m <sup>2</sup> / h, 1291 f <sup>2</sup> / h on full depth

### Physical parameters

Weight kg / lbs	323 kg / 712 lbs
Dimensions cm / inch	138×71×113 cm / 54×28×45"

### Field of application

**Depending on the blade type, hard, brittle to firm or elastic surface materials can be worked e.g.:**

- Asphalt and cast asphalt surfaces
- Concrete and cement, synthetic stone, floor tiles
- Screeds of cement, wood cement, ceramic etc.
- Natural stone
- Thermoplastic materials

**Surfaces made of highly elastic soft materials or fabrics and fiber materials cannot be worked, or can only be worked with certain limitations e.g.:**





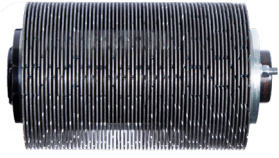

- Latex, rubber, soft plastics and foam materials
- Wood, carpets and woven materials

**NOTE:** The machines are delivered without any blades, drums or sets!

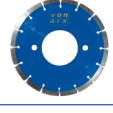

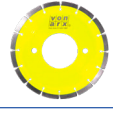
# SPARE PARTS





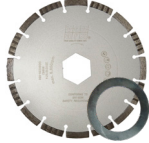

Complete drum 350 mm width					
Article code	Blade count	Spacer count	Space inbetween	Concrete type	
600306	27	80 × 4 mm	12 mm	Regular	
800038	53	54 × 5 mm	5 mm	Regular	
800142	59	63 × 4 mm	4 mm	Regular	
800037	27	80 × 4 mm	12 mm	Hard	
800039	53	54 × 5 mm	5 mm	Hard	
800143	59	63 × 2 mm	4 mm	Hard	
800150	27	80 × 4 mm	12 mm	Super Hard	
800153	53	54 × 5 mm	5 mm	Super Hard	
800156	78	79 × 3 mm	3 mm	Super Hard	

Blades set for drum 350 mm width					
Article code	Blade count	Spacer count	Space inbetween	Concrete type	
800043	27	80 × 4 mm	12 mm	Regular	
800045	53	54 × 5 mm	5 mm	Regular	
800145	59	63 × 4 mm	4 mm	Regular	
800044	27	80 × 4 mm	12 mm	Hard	
800046	53	54 × 5 mm	5 mm	Hard	
800050	59	63 × 4 mm	4 mm	Hard	
800151	27	80 × 4 mm	12 mm	Super Hard	
800154	53	54 × 5 mm	5 mm	Super Hard	
800157	78	79 × 3 mm	3 mm	Super Hard	

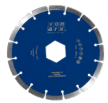

Single parts for drum					Single parts for drum				
Type	Size	Concrete type	Article code		Type	Size	Article code		
Single blade	230 mm / 9"	Regular	600951		Spacer	3 mm	601106		
Single blade	230 mm / 9"	Hard	600950		Spacer	4 mm	600948		
Single blade	230 mm / 9"	Super Hard	601103		Spacer	5 mm	600949		
					Empty drum		800113		

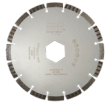
# SPARE PARTS

Blades set for shaft 350 mm width					
Article code	Blade count	Spacer count	Space inbetween	Concrete type	
800101	27	80 × 4 mm & 12 × 5 mm	12 mm	Regular	
800102	53	54 × 5 mm & 12 × 5 mm	5 mm	Regular	
800148	59	77 × 4 mm	4 mm	Regular	
800104	27	80 × 4 mm & 12 × 5 mm	12 mm	Hard	
800105	53	54 × 5 mm & 12 × 5 mm	5 mm	Hard	
800147	59	77 × 4 mm	4 mm	Hard	
800152	27	80 × 4 mm & 12 × 5 mm	12 mm	Super Hard	
800155	53	54 × 5 mm & 12 × 5 mm	5 mm	Super Hard	
800158	78	79 × 3 mm & 12 × 5 mm	3 mm	Super Hard	

Single parts for drum					Single parts for drum				
Article code	Type	Size	Concrete type		Article code	Type	Size		
600649	Single blade	230 mm / 9"	Regular		600258	Spacer	4 mm		
600648	Single blade	230 mm / 9"	Hard		600364	Spacer	5 mm		
601101	Single blade	230 mm / 9"	Super Hard		601106	Spacer	3 mm		

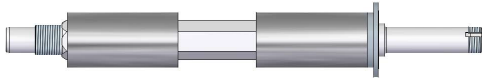
# ACCESSOIRES

Distance sets		
800119	Distance bush shaft set 10 cm	
800120	Distance bush shaft set 15 cm	
800121	Distance bush shaft set 17 cm	
800122	Distance bush shaft set 20 cm	
800123	Distance bush shaft set 25 cm	
800124	Distance bush drum set 10 cm	
800125	Distance bush drum set 15 cm	
800126	Distance bush drum set 17 cm	
800127	Distance bush drum set 20 cm	
800128	Distance bush drum set 25 cm	

**NOTE:** The sets consists of three bushings: two custom made and one universal.

Article code	Type		Article code	Type	
600956	Weight set		600969	Lifting point set	
600963	Aiming device complete		600971	Wheel protector set	
600970	4" to 3" camlock adapter set		800167	Laser pointing kit	

**NOTE:** All accessories are supplied with their respective fasteners.